



The Power of Voice on the Internet

Tom Evslin
Chairman and CEO

ITXC[®]

© 2003 ITXC Corp. ® All rights reserved. Proprietary and Confidential.

Total VoIP and PSTN Traffic, 1997-2002

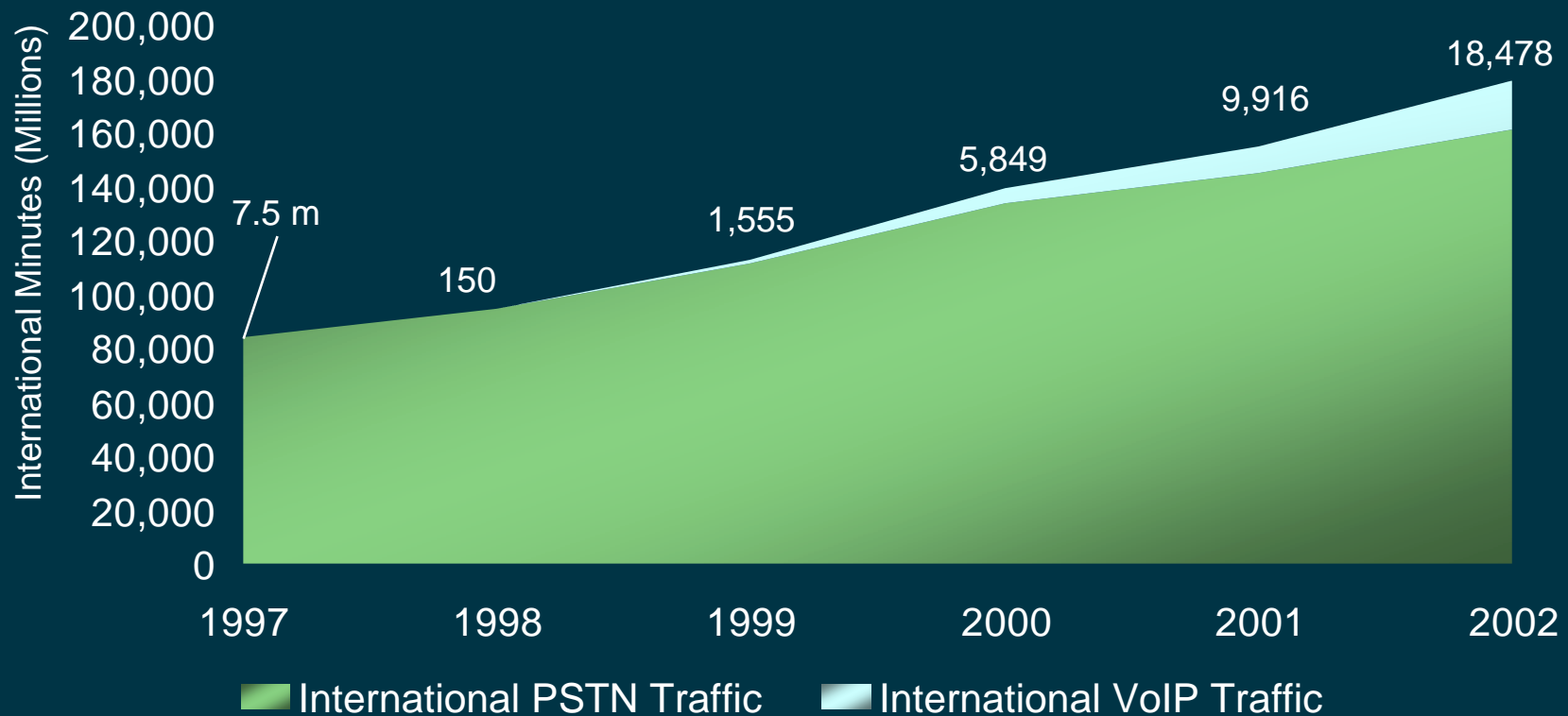

Note: Voice-over-IP (VoIP) traffic includes all cross-border voice calls carried on IP networks but terminated on public switched telephone network; PC-to-PC communications and private network traffic are excluded. PSTN traffic includes circuit-switched voice and fax traffic carried on traditional international facilities as well as international simple resale (ISR) facilities. Figures for 2002 are estimated. Source: TeleGeography research. © TeleGeography, Inc. 2002

Wholesale VoIP Service Forecast (Minutes in Millions), 2000-2005

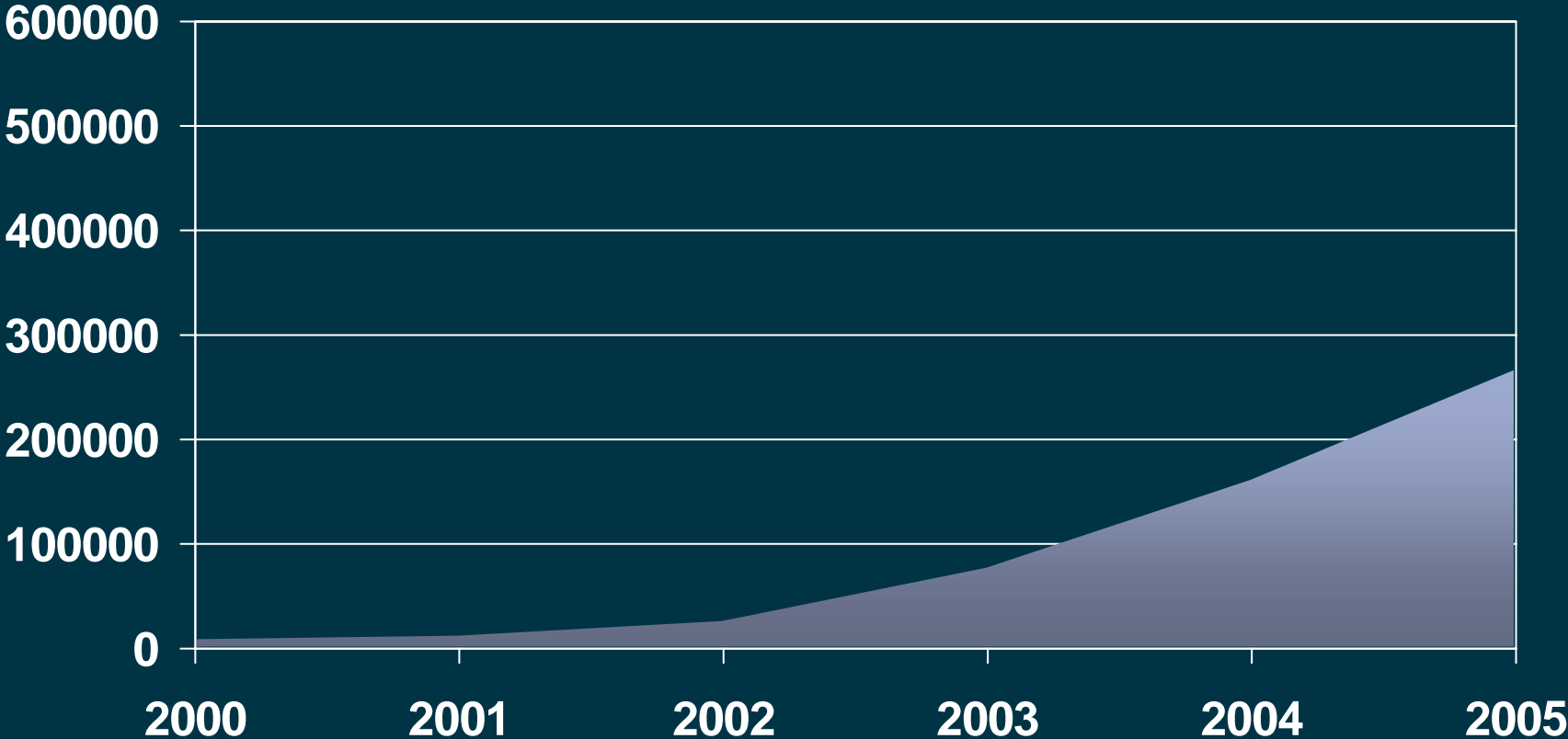

Source: Frost & Sullivan, February 2003

■ Wholesale



Market Share of International VoIP Minutes, 1998-2002

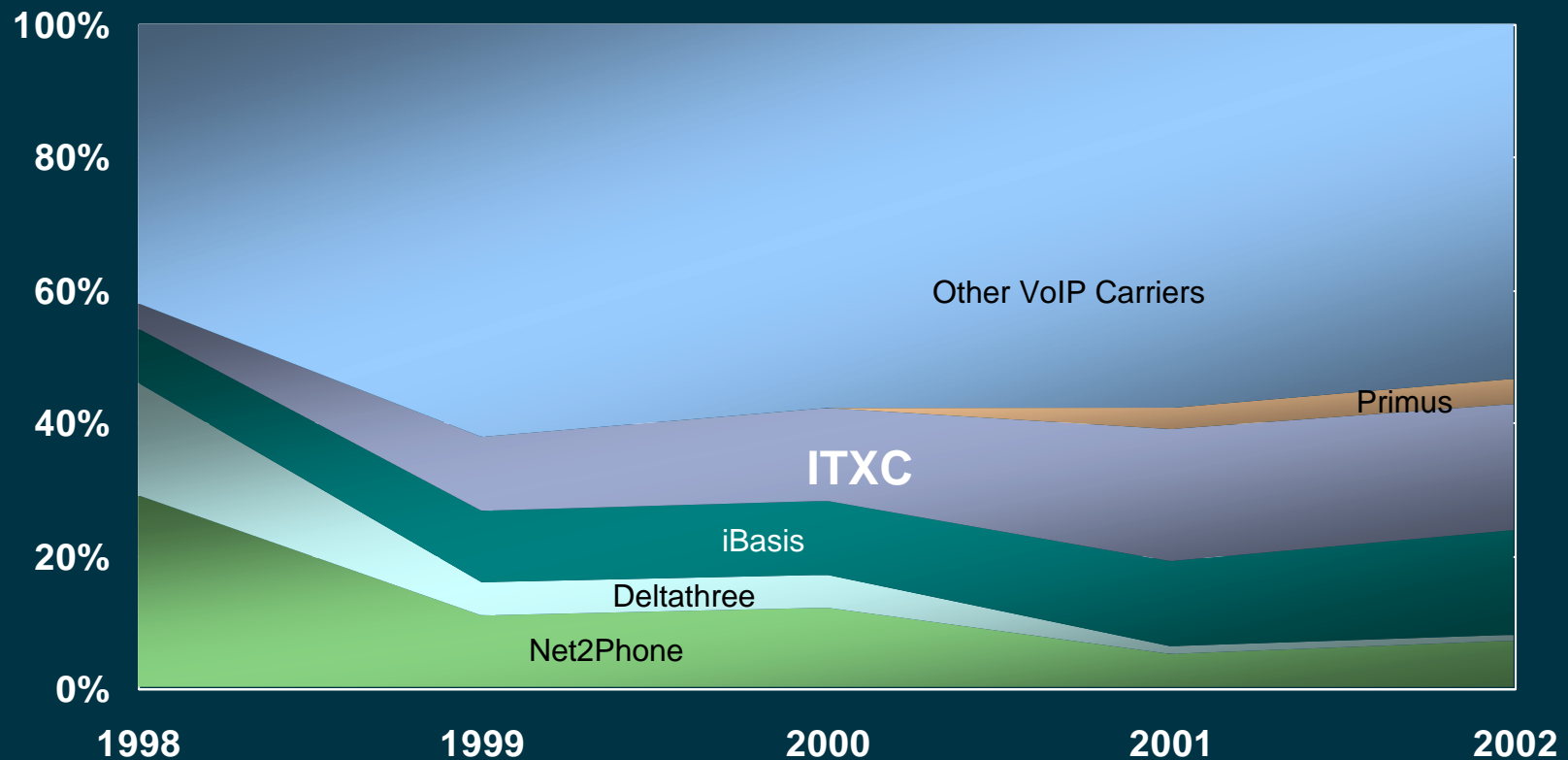

Source: TeleGeography research and company reports. © TeleGeography, Inc. 2002

Note: Traffic statistics include only international VoIP minutes

ITXC

© 2003 ITXC Corp. ® All rights reserved. Proprietary and Confidential.

ITXC Quarterly Revenue

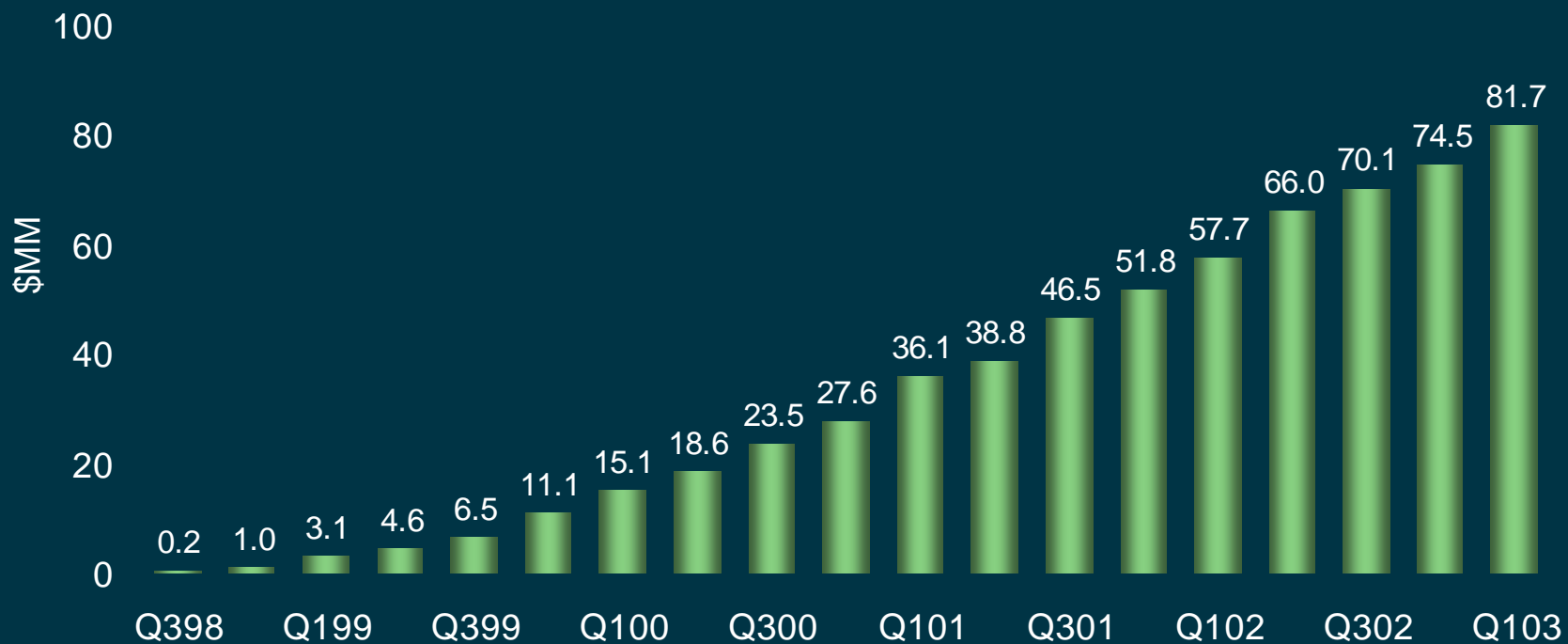

ITXC one of the World's Leading International Carriers

Top 10 Carriers in 2001 based on Annual International Minutes of Use in Millions

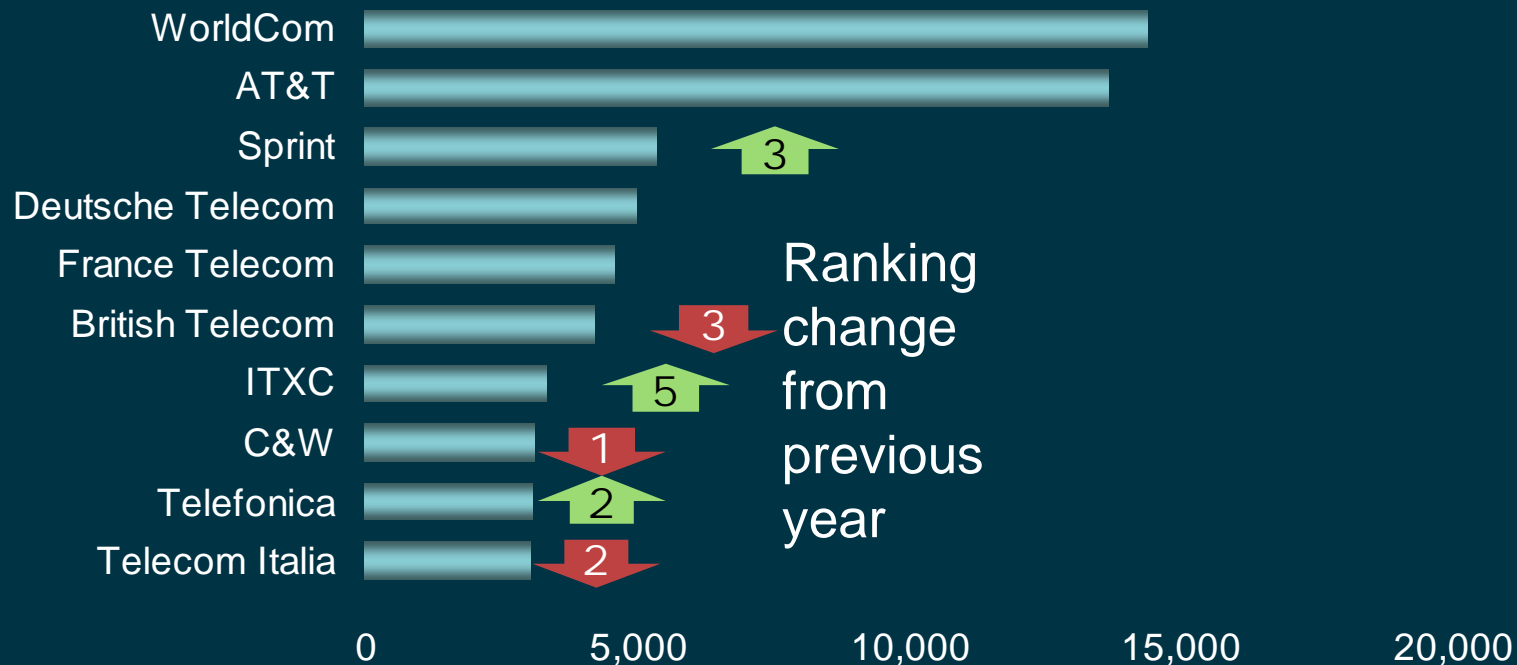

Source: TeleGeography research. © TeleGeography, Inc. 2002. Note: ITXC data is 2002. All other carriers are 2001 which is latest available. WorldCom, AT&T, and C&W data includes traffic from multiple countries of origin documented in the list of the top 40.



Inherent Benefits of Building on the Internet

- Fully meshed network
- Distance insensitive cost structure
- Ubiquitous presence
- Highly resilient
- Low capital/recurring costs

A Fully Meshed Network

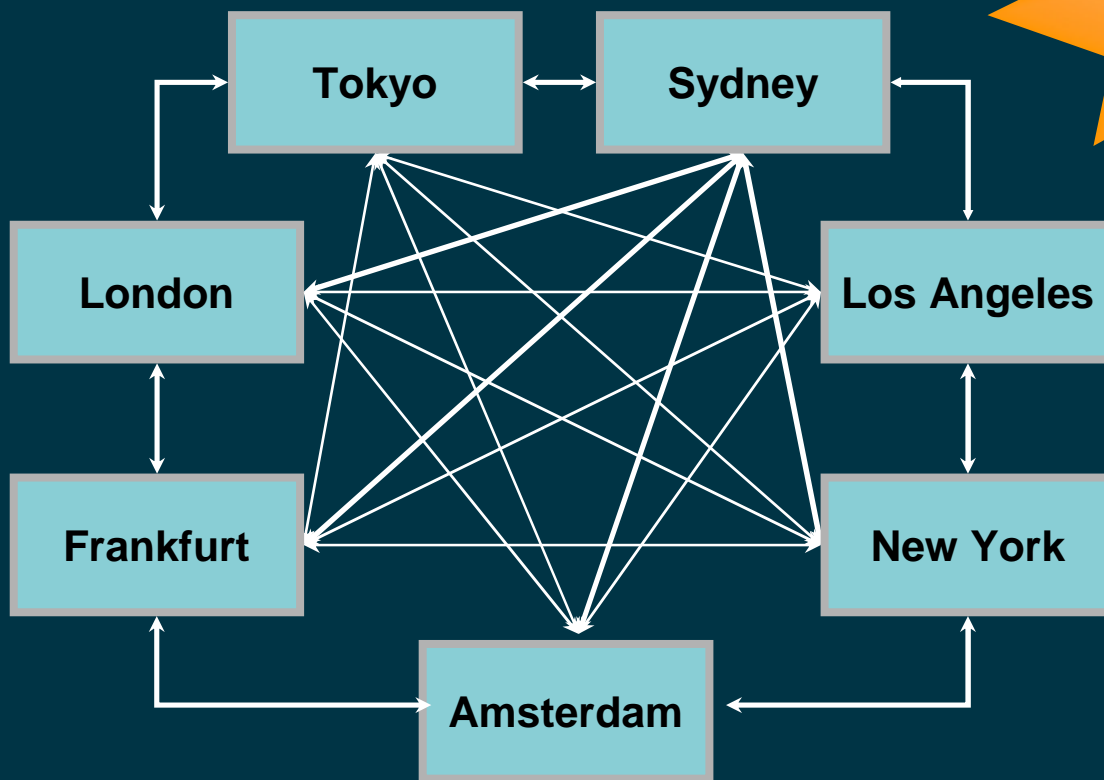

Add a PoP for
\$225,816 More;
Cost Increases with
each new PoP

7 PoPs

7 cities each with an E1 (2 Mbps) connection to each of the others.

21 E1s
\$1,029,472
a month

Source: Lynx Global Telecom Database 5/03 and Bandwidthmarket.com. Prices based on fiber optic capacity and a 1 year contract. Prices exclude local loop charges and taxes.



Cost Efficient Internet-based Network; Pops Added at Linear Cost

\$5,400 to add an IP PoP!

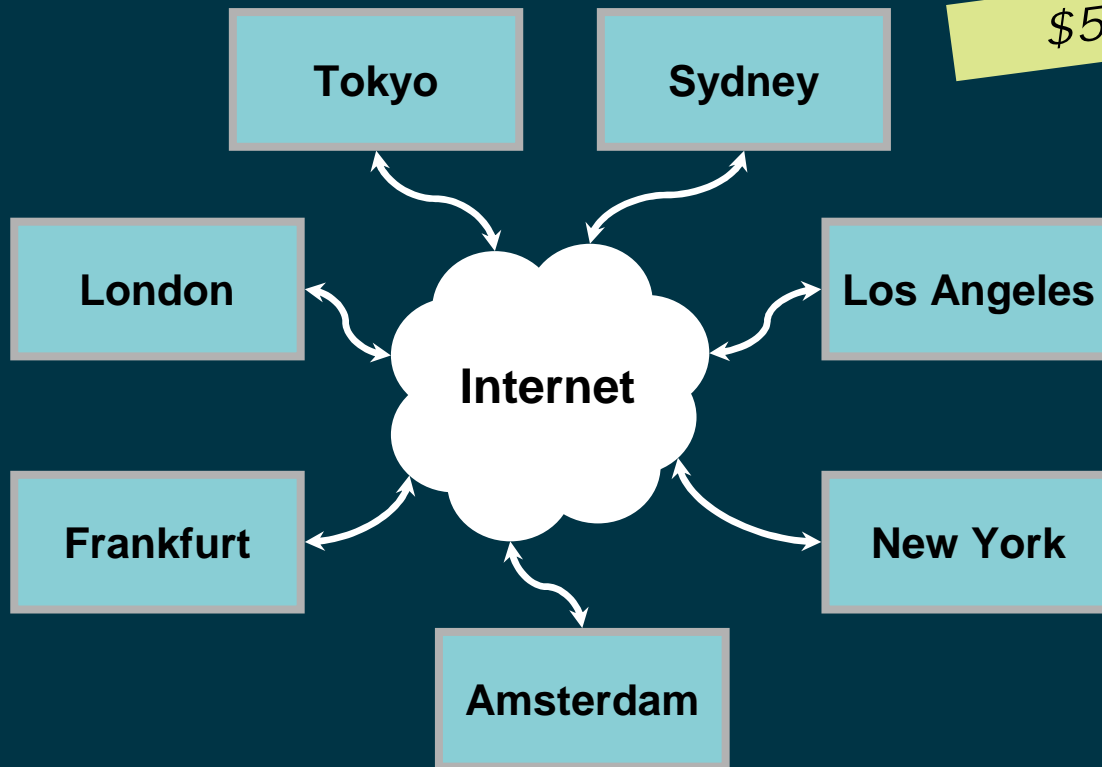

7 PoPs

7 cities each with
an 6 Mbps Internet
connection

\$63,987

a month

Source: MCI (WorldCom) public pricing and Bandwidthmarket.com. Prices only include monthly recurring charges and do not account for installation charges or taxes. 6MB price = 3 x 2MB price.

ITXC

© 2003 ITXC Corp. ® All rights reserved. Proprietary and Confidential.

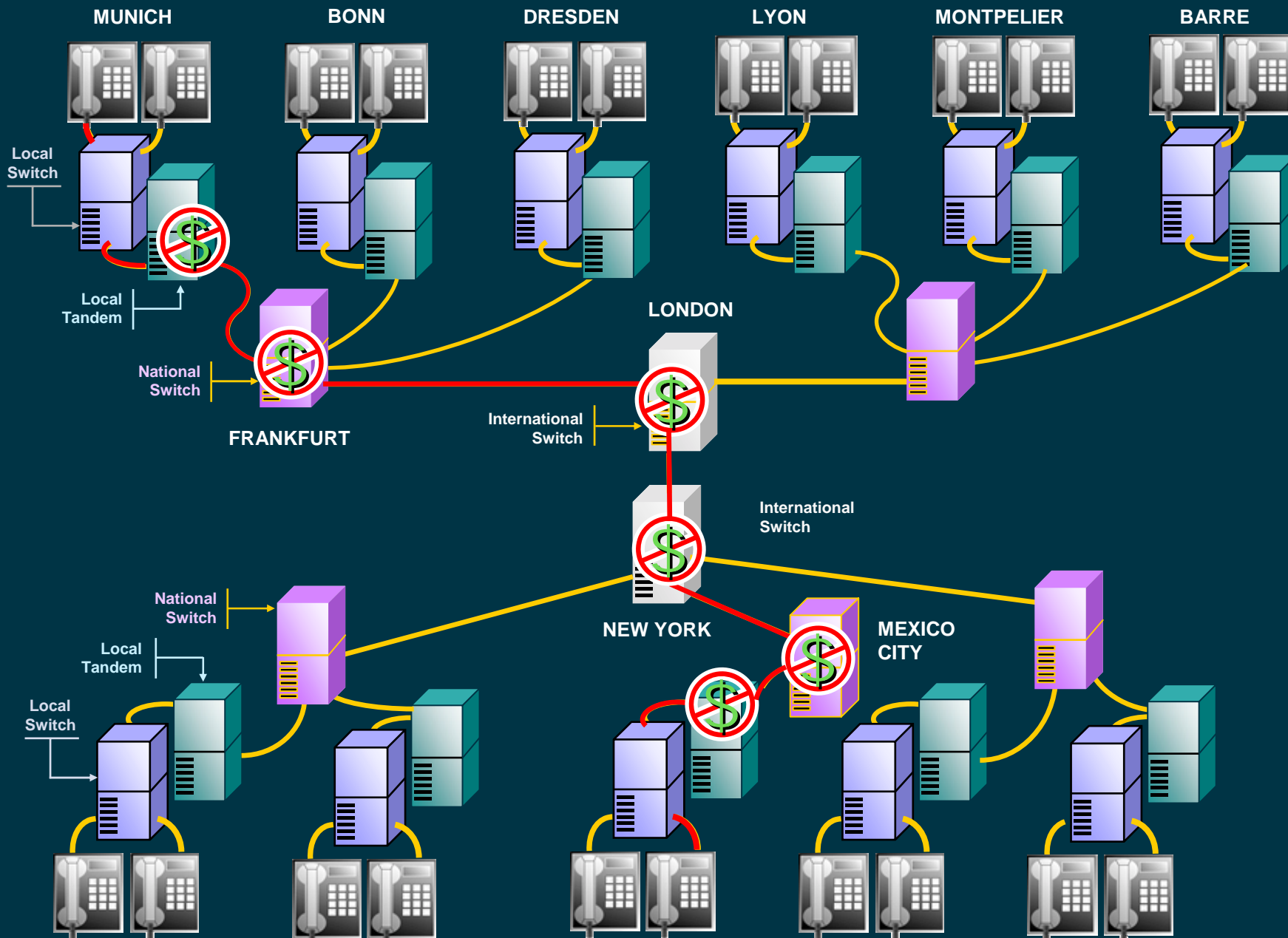

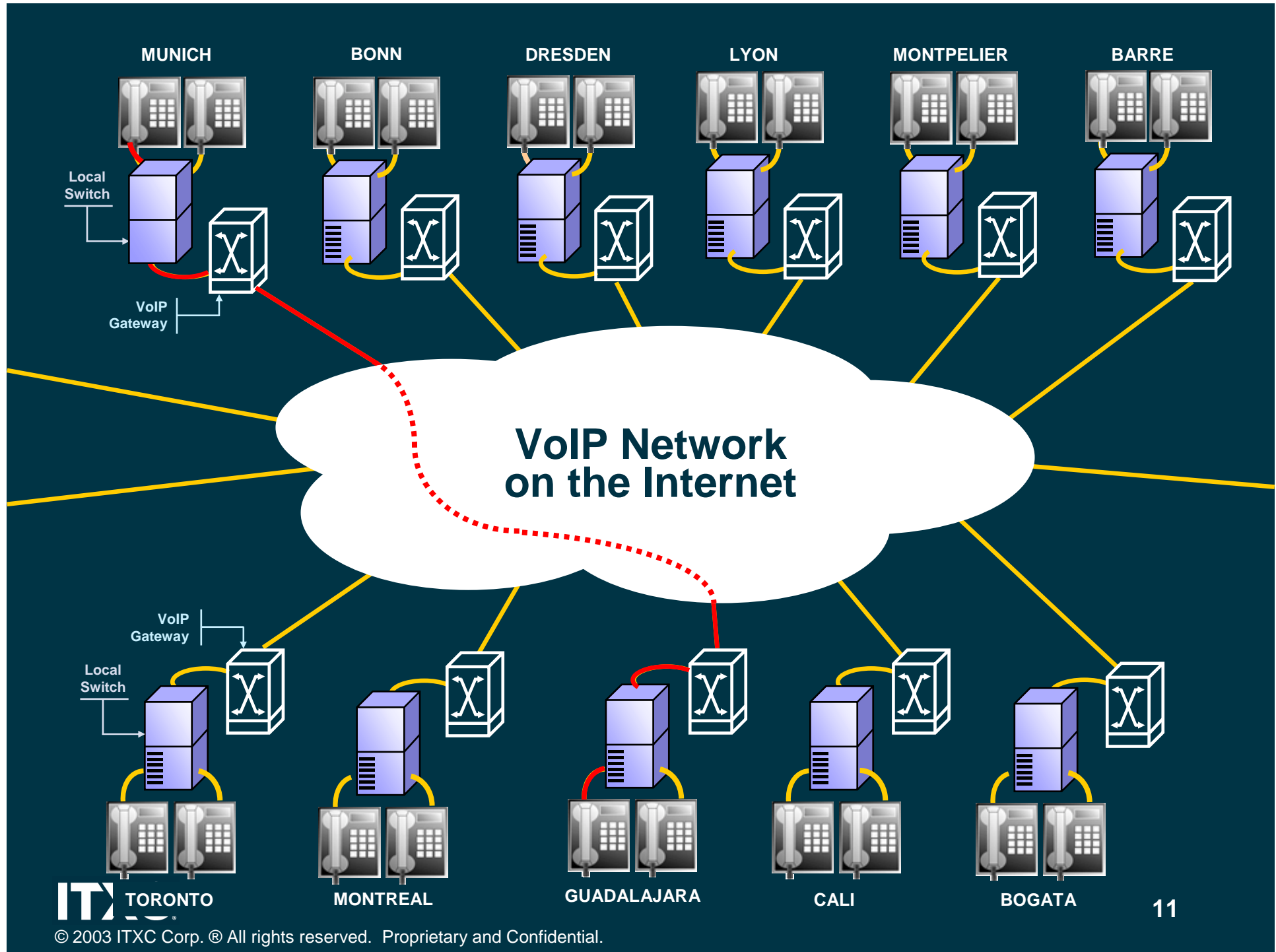

Enterprise IP Telephony Equipment 2003: An Inflection Point in the Industry

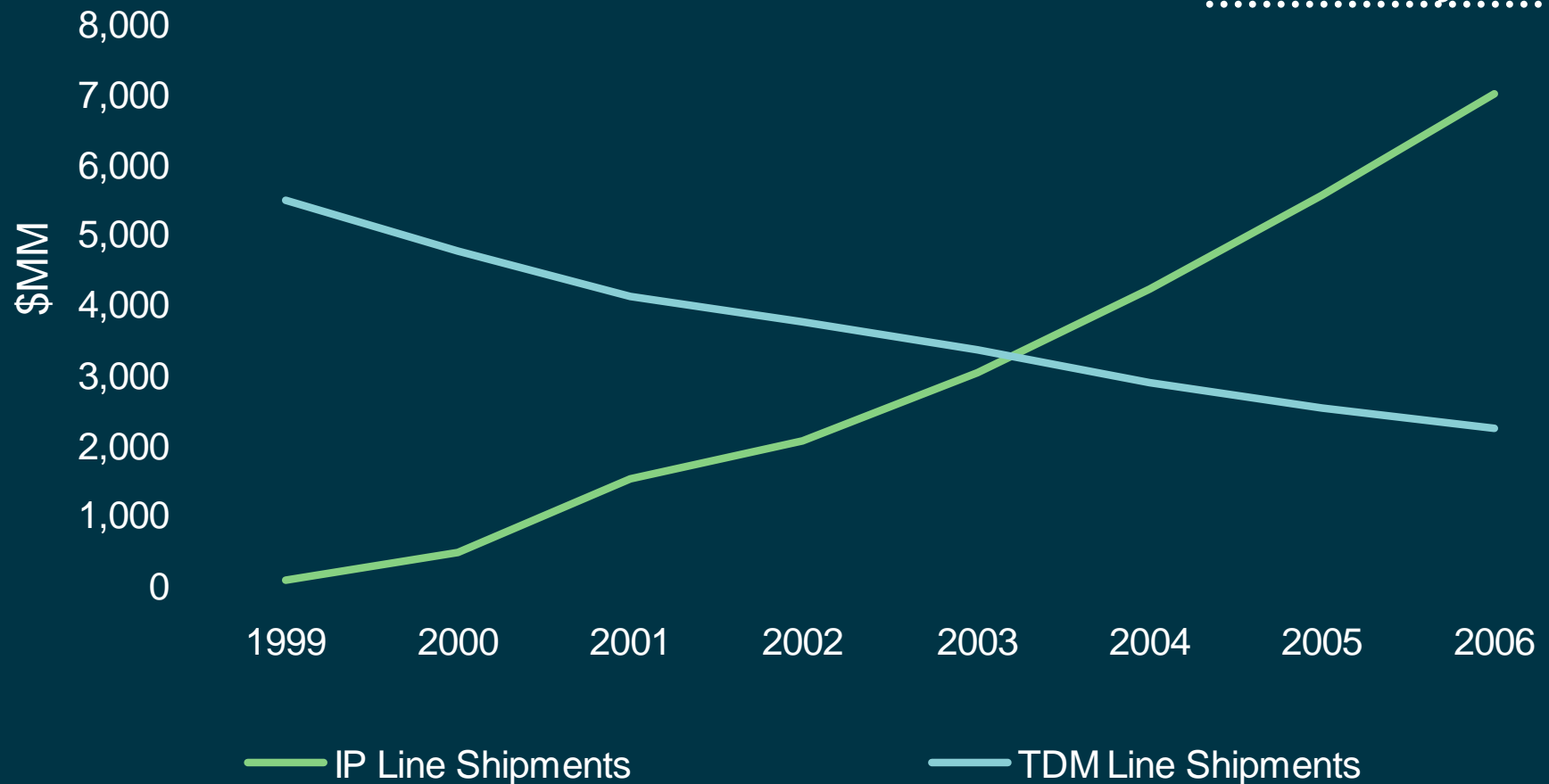

Source: InfoTech, December 2002
TDM line shipments for PBXs
IP line shipments for IP, IP-Enabled & Converged Systems

ITXC

© 2003 ITXC Corp. ® All rights reserved. Proprietary and Confidential.

Growth of IP PBX's

% of Enterprise Telephone Stations Sold in the U.S. that are IP-based

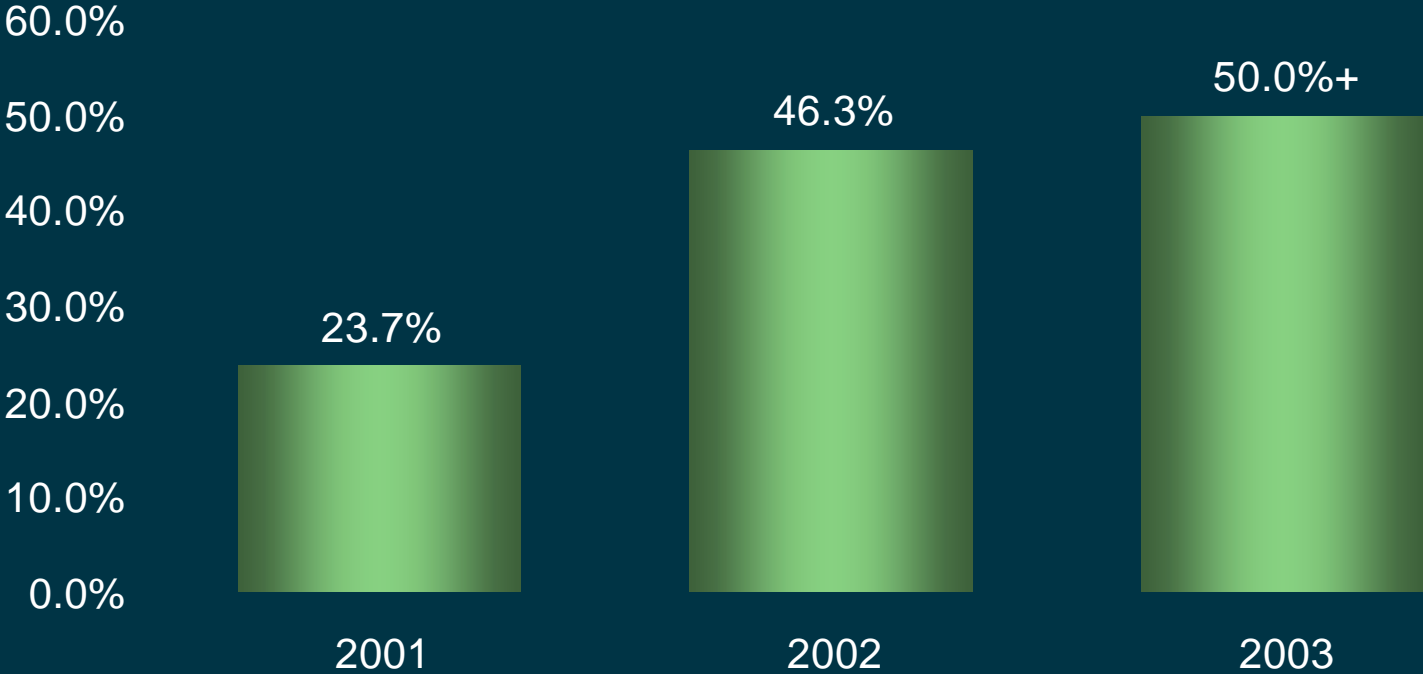

Source: In-Stat/MDR



© 2003 ITXC Corp. ® All rights reserved. Proprietary and Confidential.

Enterprise VoIP Service Forecast (Minutes in Millions), 2000-2005

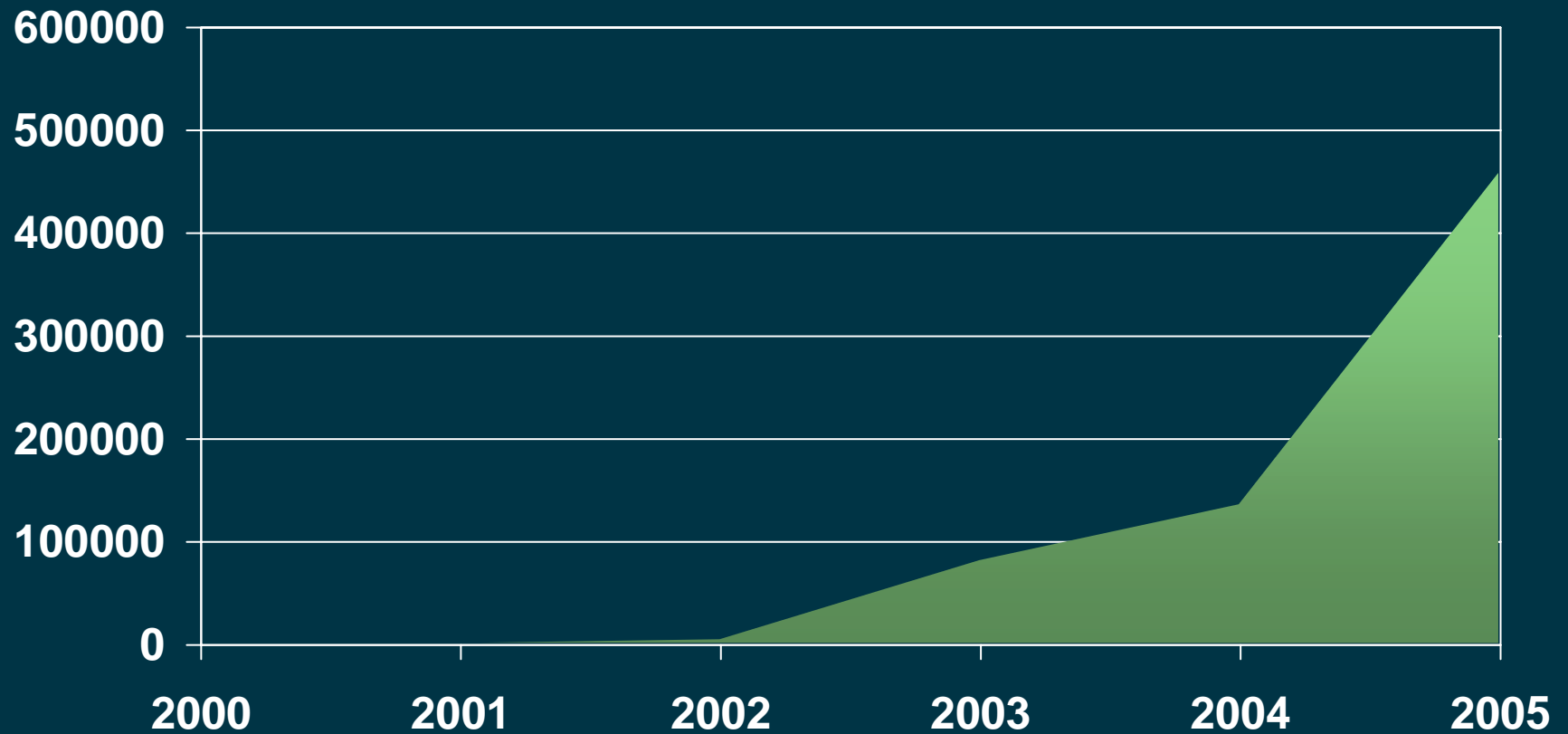

Source: Frost & Sullivan, February 2003

■ Enterprise

ITXC

© 2003 ITXC Corp. ® All rights reserved. Proprietary and Confidential.

Corporate Customer Today

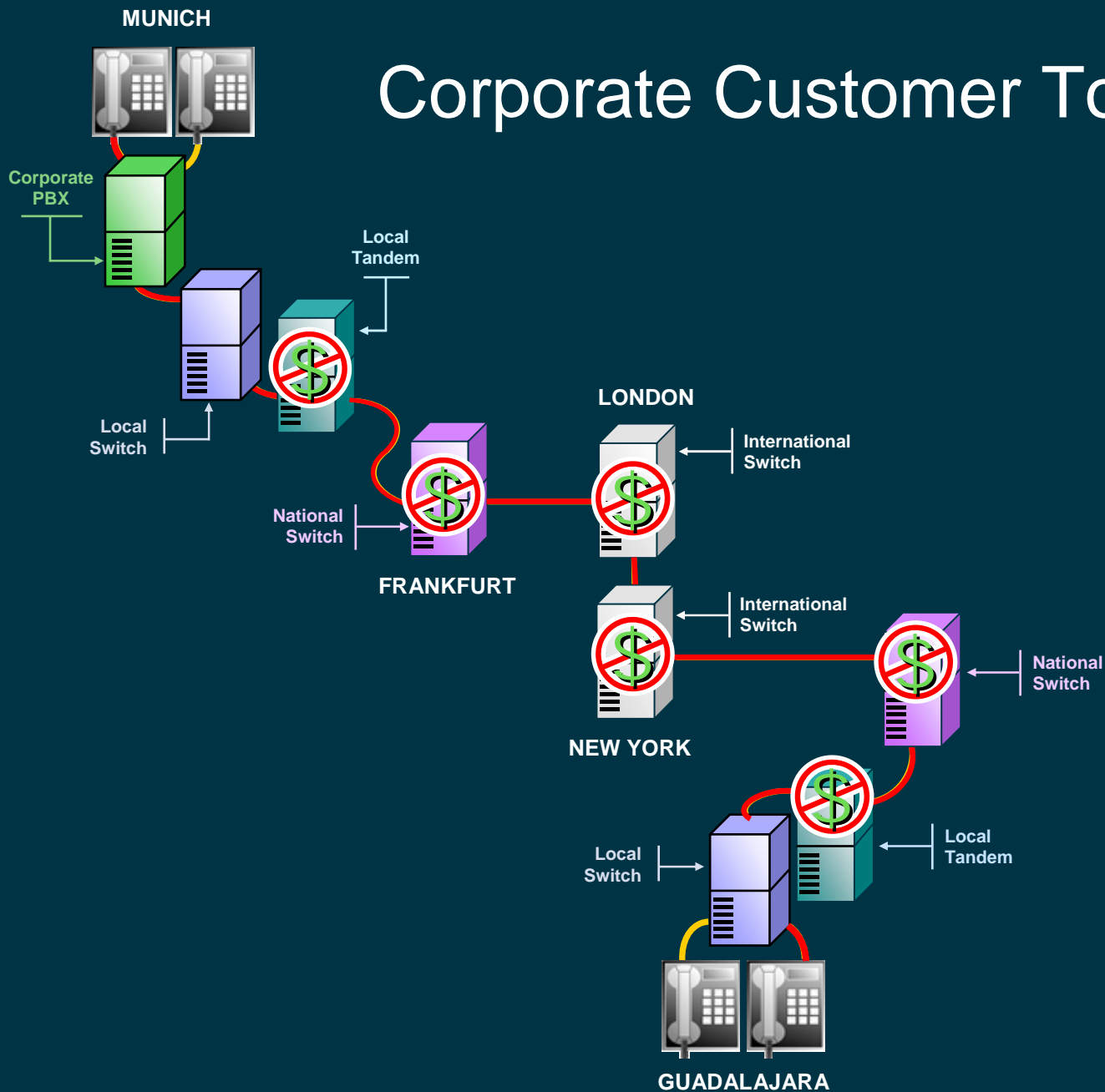

The Significance of VoIP on Customer Premises

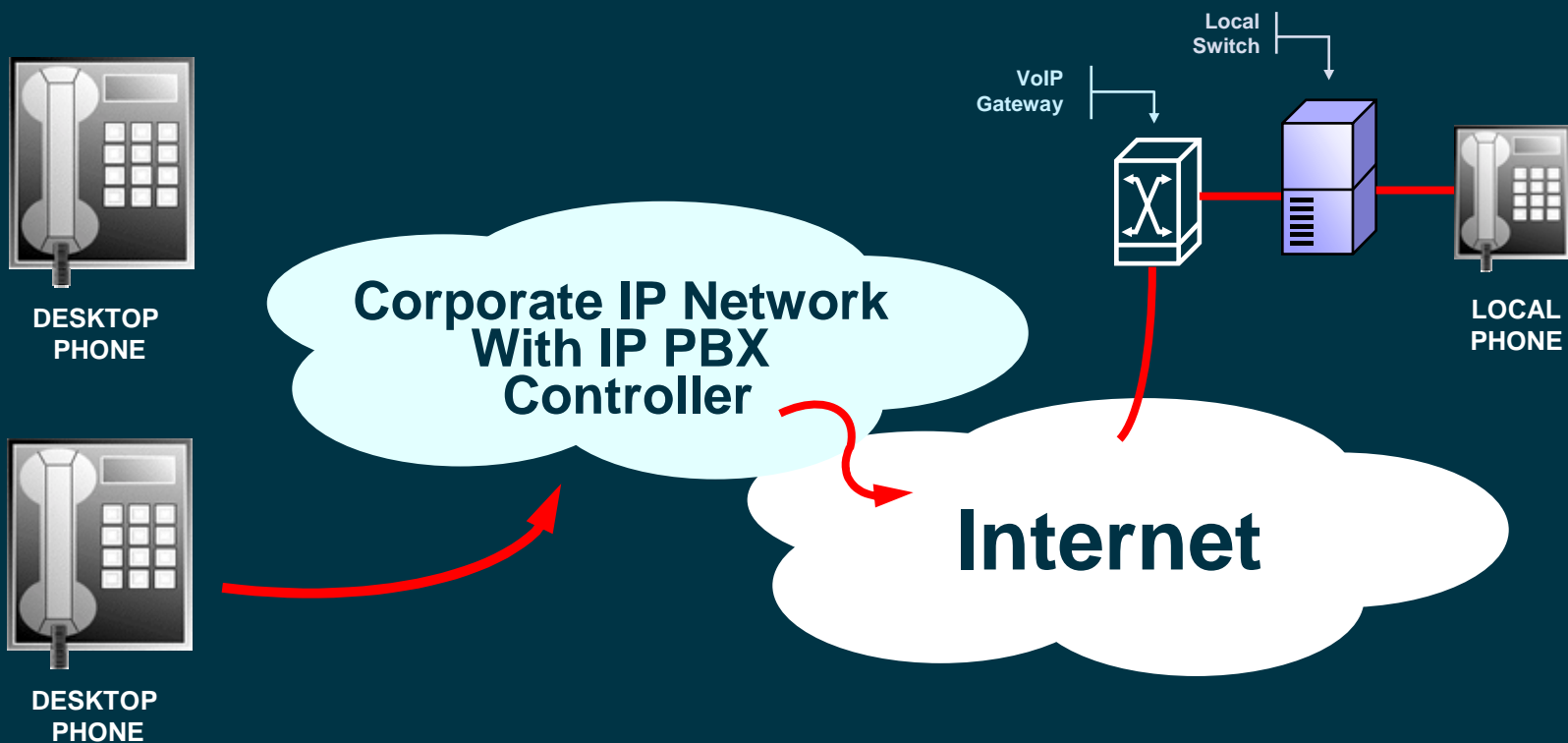

Consumer VoIP Service Forecast (Minutes in Millions), 2000-2005

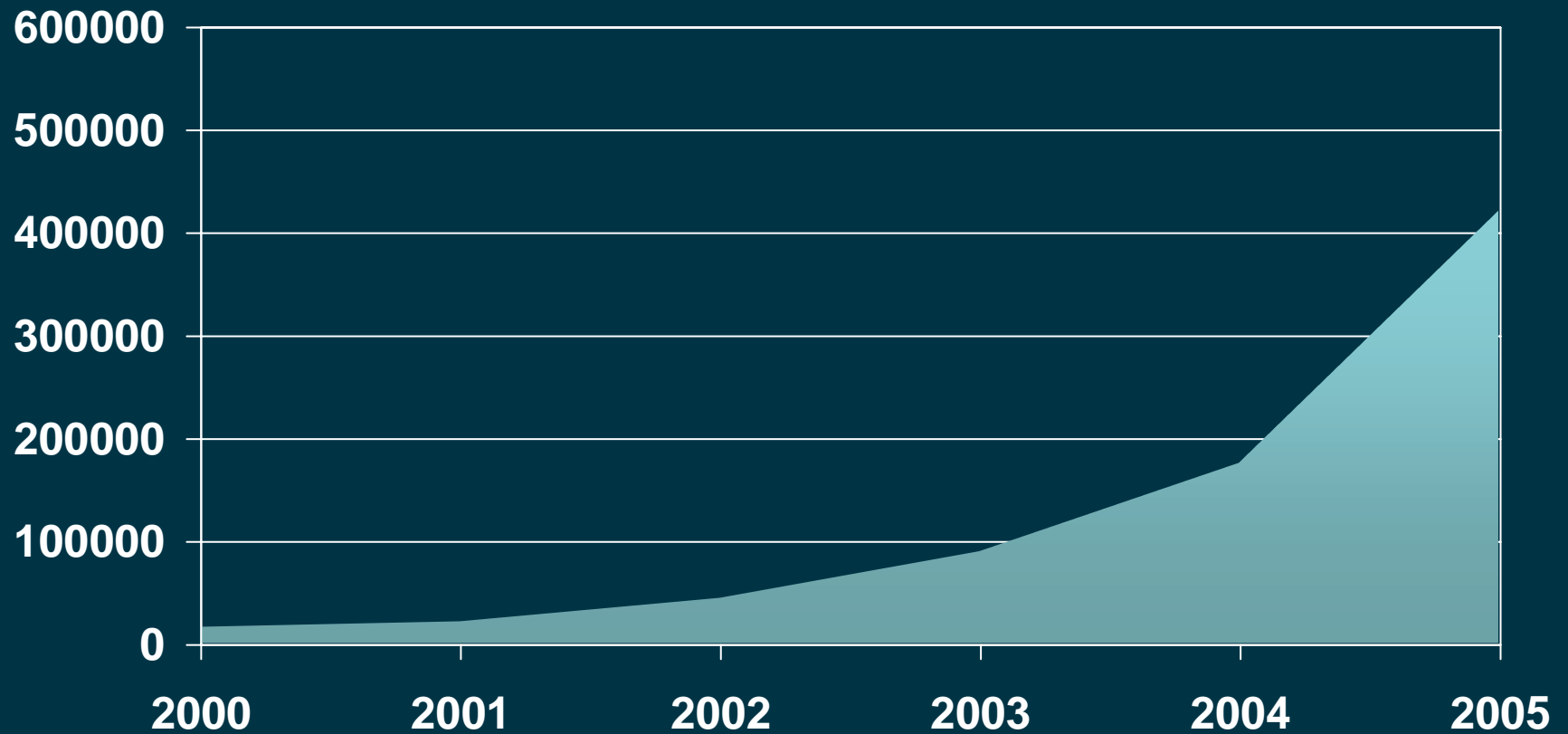

Source: Frost & Sullivan, February 2003

■ Consumer

ITXC

© 2003 ITXC Corp. ® All rights reserved. Proprietary and Confidential.

Total VoIP Service Forecast (Minutes in Millions), 2000-2005

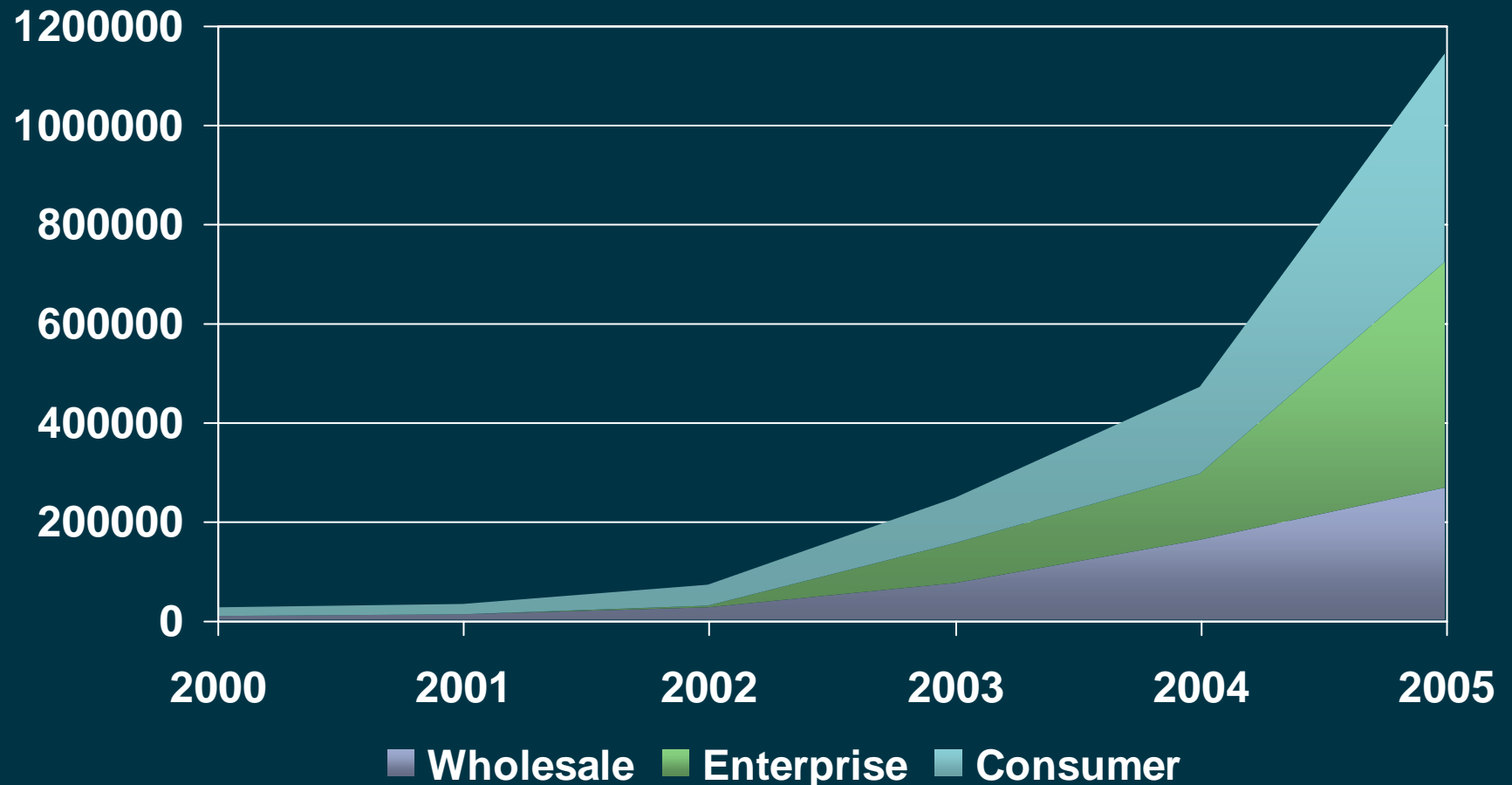

Source: Frost & Sullivan, February 2003

ITXC

© 2003 ITXC Corp. ® All rights reserved. Proprietary and Confidential.

All Voice will be on the Internet by 2010

.....

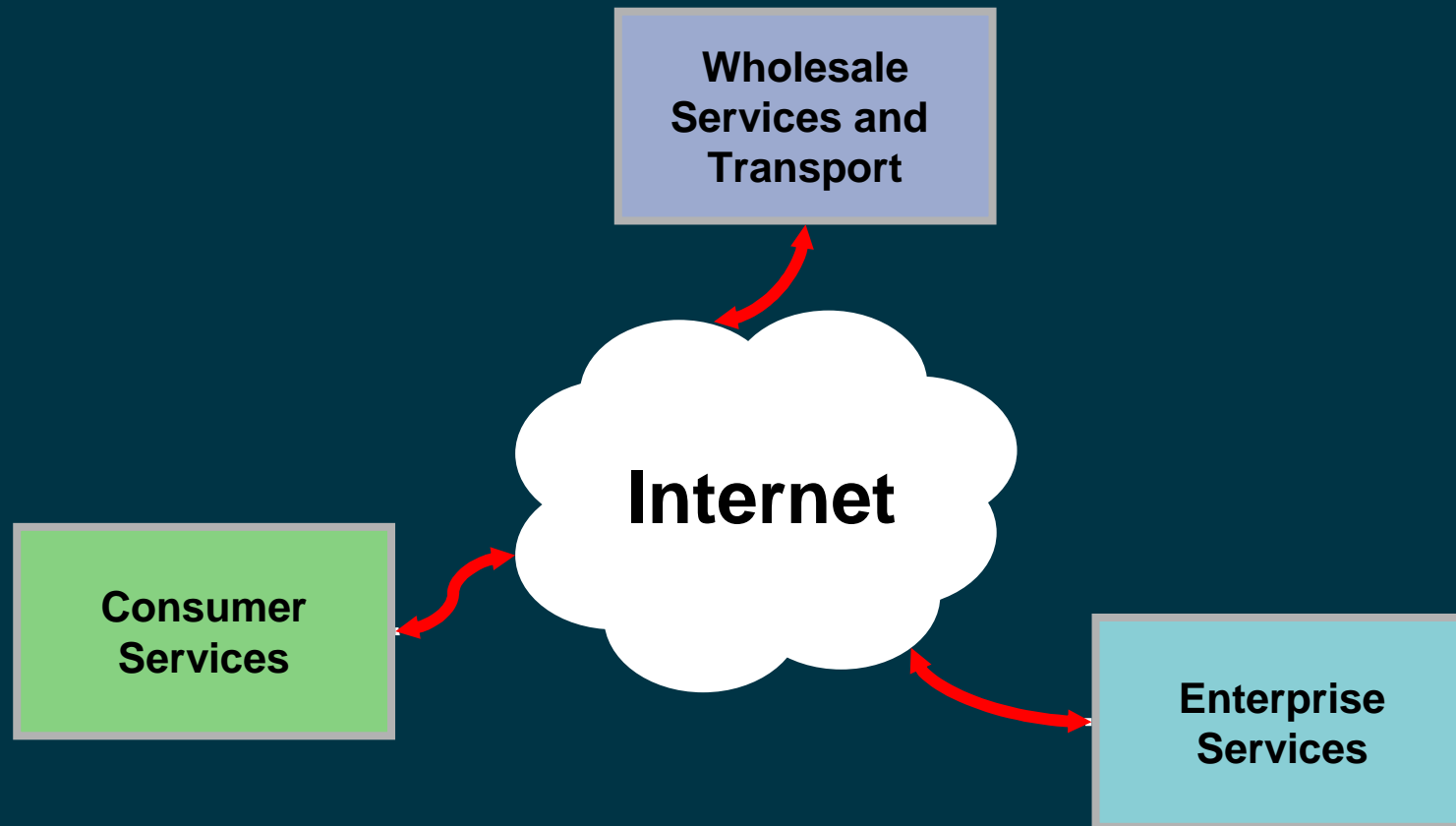

ITXC Worldwide

Tom Evslin
Chairman and CEO



Over 175 countries through direct traffic relationships with over hundreds of national and global carriers

London +44.207.872.5623	Frankfurt +49.06196.920.2.190	Tel Aviv +972.3.7783007	Johannesburg +27.11.258.85.68	Moscow +7.095.9987752
Singapore +65 68385298	Sydney +61.402.000660	Hong Kong +852.91901231	Bangalore +91.98440.32675	Tokyo +81.90.9813.3977
Manila +63.917.539.6796	Miami +1.305.443.9444	Buenos Aires +54.114.978.4566	Sao Paulo +55.11.9656.4710	Santiago +562.209.8278

ITXC

© 2003 ITXC Corp. ® All rights reserved. Proprietary and Confidential.